



**HIGH INDUCTION DIFFUSERS WITH
VARIABLE GEOMETRY**

KQ - 2
KQ - 2 R
SERIES

**TECHNICAL DRAWINGS
CONSTRUCTION DIMENSIONS**

CONSTRUCTION DIMENSIONS :

Figure no. 3

Standard square and circular construction with vertical or horizontal throw

KQ2 300x300 400x400 500x500

KQ2 R Ø 300 Ø 400 Ø 500

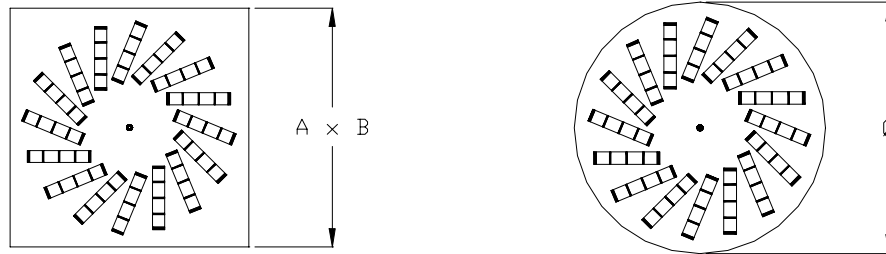
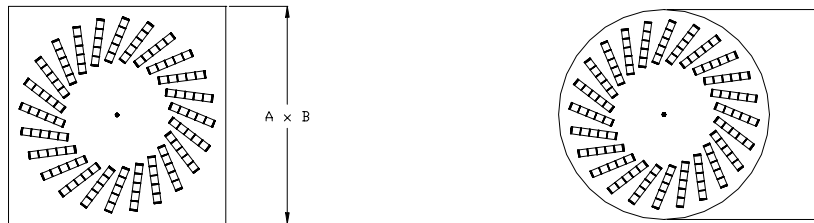

Figure no. 4

Standard square and circular construction with vertical or horizontal throw

KQ2 600x600 625x625

KQ2 R Ø 600 Ø 625



Nominal diameter	A [mm]	B [mm]	Ø
300	296	296	296
400	396	396	396
500	496	496	496
600	596	596	596
625	621	621	

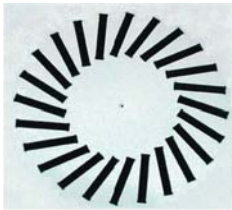

HIGH INDUCTION DIFFUSERS WITH VARIABLE GEOMETRY

HOW TO USE THE GRAPHS

KQ - 2
KQ - 2 R
SERIES

CORRECT METHOD FOR USING THE KQ2 SERIES GRAPHS

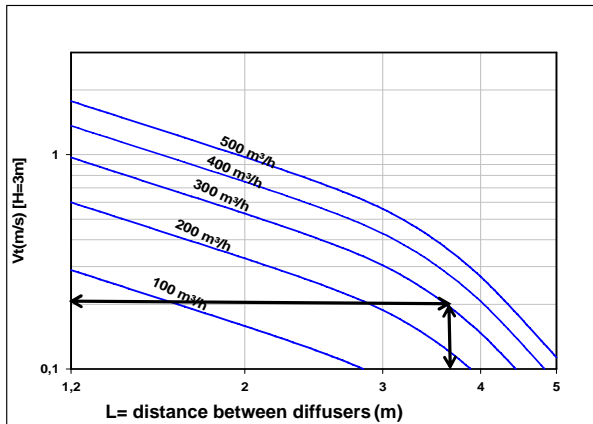

INSTRUCTION 1

Calculation of the proposed distance between the diffusers in relation of the air flow and the speed required at the limit of the occupied zone, equal to 1,8m from floor level.

As an alternative, calculate the speed at the limit of the occupied zone in relation to the air flow and the distance between the diffusers.

The values obtained are valid for ceilings of 3m. For different heights, it will be necessary to apply the correction factor calculated from the table shown in the selection page

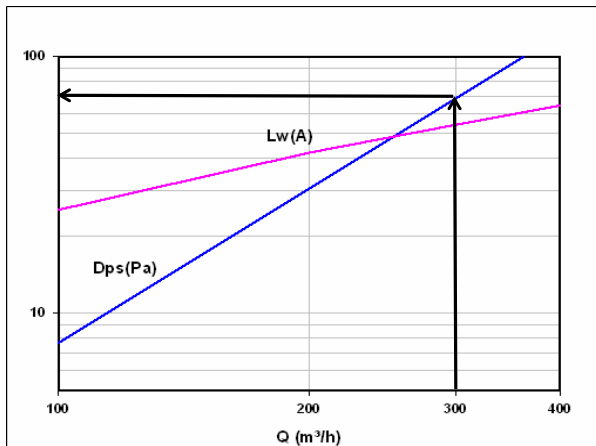

INSTRUCTION 2

Calculation of the loss of the static pressure loss ΔP_s in relation of the air flow rate.

Pressure loss indicated in Pa.

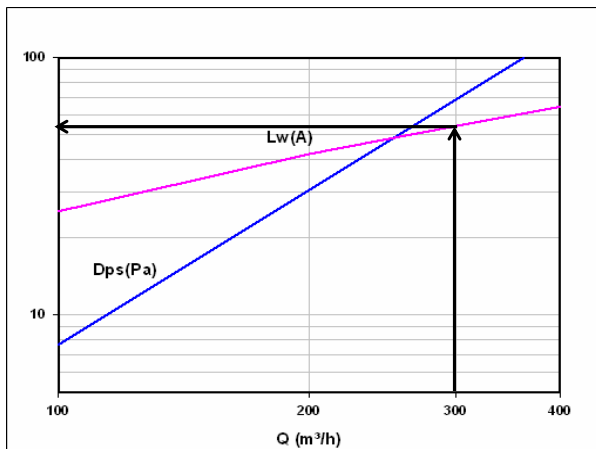

INSTRUCTION 3

Calculation of the noise power level Lw in relation of the air flow rate.

Noise power level indicated in dBa.

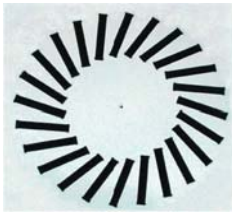

**HIGH INDUCTION DIFFUSERS WITH
VARIABLE GEOMETRY**

PERFORMANCE KQ2-300

KQ - 2
SERIES

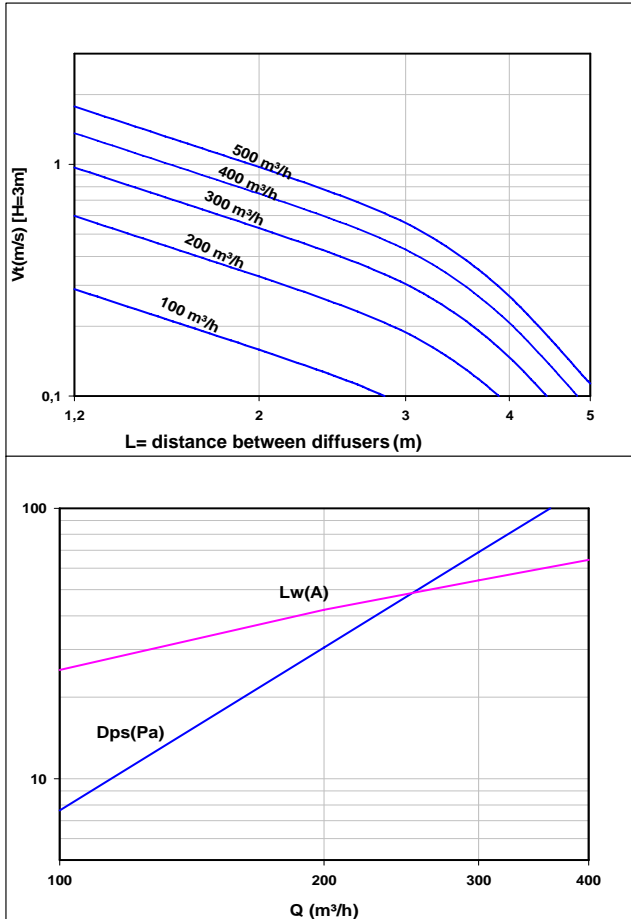

Dps= Static pressure loss (Pa)
measure with steel sheet plenum,

Lw(A)= Acoustic power level
pondered in 'A' dB(A)

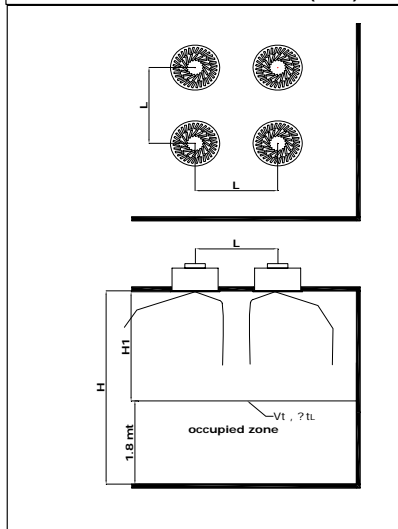

Legend:

H height of installation

1,8m height of occupied zone

Values are expressed in isothermic conditions $\Delta T=0$ K

ΔT =Temperature difference between injected air and room temperature.

Conversion table for different installation heights.

H(m)	K
2,70	1,33
3,00	1,00
3,40	0,75
3,80	0,60

example:

H=3,4 m

$$Vt(H=3,4)=Vt(H=3) \times K=Vt(H=3) \times 0,75$$

For installation in a open space $Vt=Vt \times 0,7$

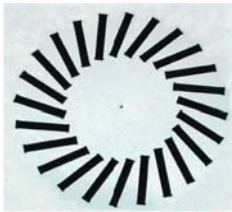

HIGH INDUCTION DIFFUSERS WITH VARIABLE GEOMETRY

PERFORMANCE KQ2-400

KQ - 2
SERIES

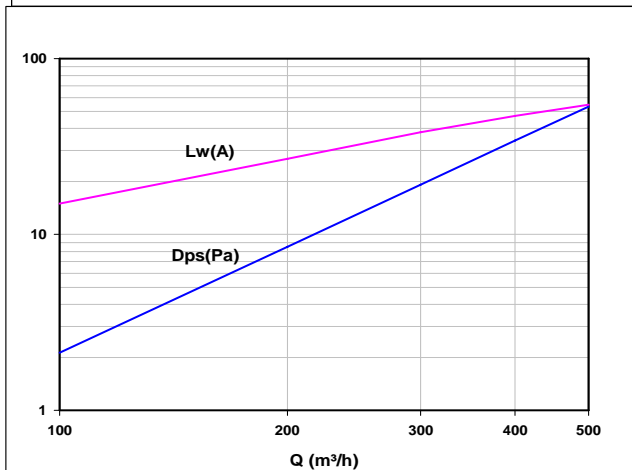
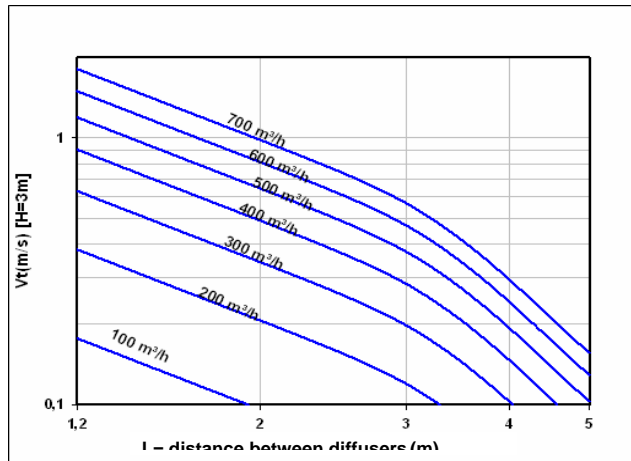

Dps= Static pressure loss (Pa)
measure with steel sheet plenum,

Lw(A)= Acoustic power level
pondered in 'A' dB(A)

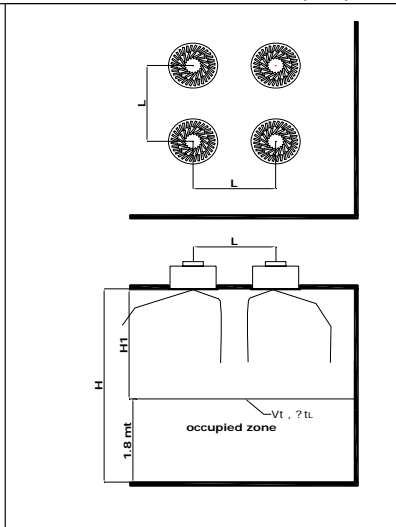

Legend:

H height of installation

1,8m height of occupied zone

Values are expressed in isothermic conditions $\Delta T=0$ K

ΔT =Temperature difference between injected air and room temperature.

Conversion table for different installation heights.

H(m)	K
2,70	1,33
3,00	1,00
3,40	0,75
3,80	0,60

example:

H=3,4 m

$Vt(H=3,4)=Vt(H=3) \times K=Vt(H=3) \times 0,75$

For installation in a open space $Vt=Vt \times 0,7$

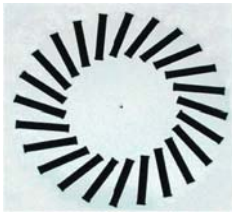

HIGH INDUCTION DIFFUSERS WITH VARIABLE GEOMETRY

PERFORMANCE KQ2-500

KQ - 2
SERIES

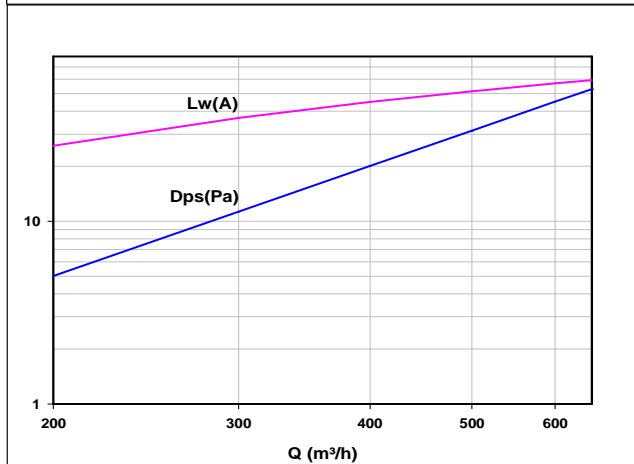
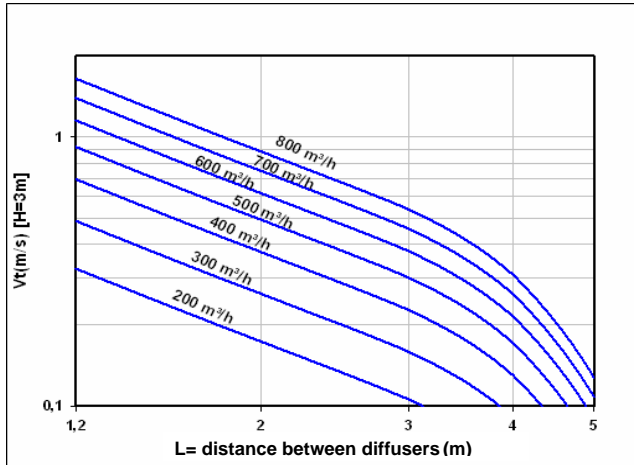

Dps = Static pressure loss (Pa)
measure with steel sheet plenum,

$Lw(A)$ = Acoustic power level
pondered in 'A' dB(A)

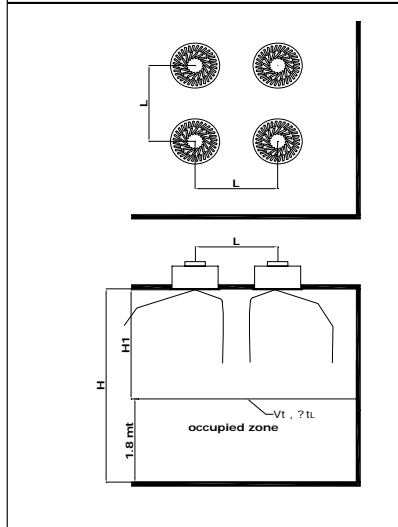

Legend:

H height of installation

1,8m height of occupied zone

Values are expressed in isothermic conditions $\Delta T=0$ K

ΔT =Temperature difference between injected air and room temperature.

Conversion table for different installation heights.

H(m)	K
2,70	1,33
3,00	1,00
3,40	0,75
3,80	0,60

example:

$H=3,4$ m

$V_t(H=3,4)=V_t(H=3) \times K=V_t(H=3) \times 0,75$

For installation in a open space $V_t=V_t \times 0,7$

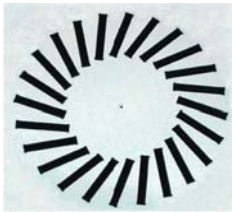

HIGH INDUCTION DIFFUSERS WITH VARIABLE GEOMETRY

PERFORMANCE KQ2-600/625

KQ - 2
SERIES

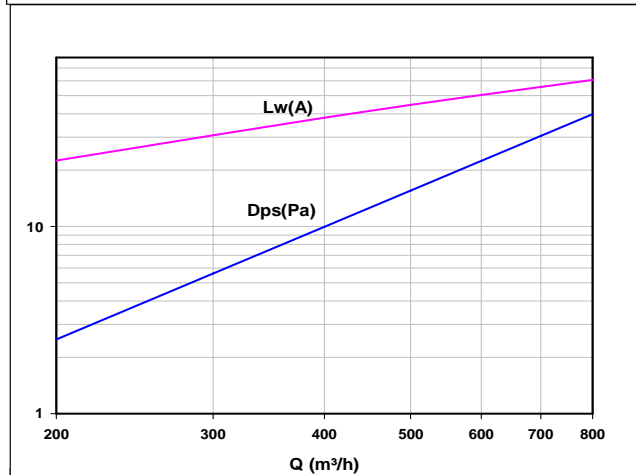
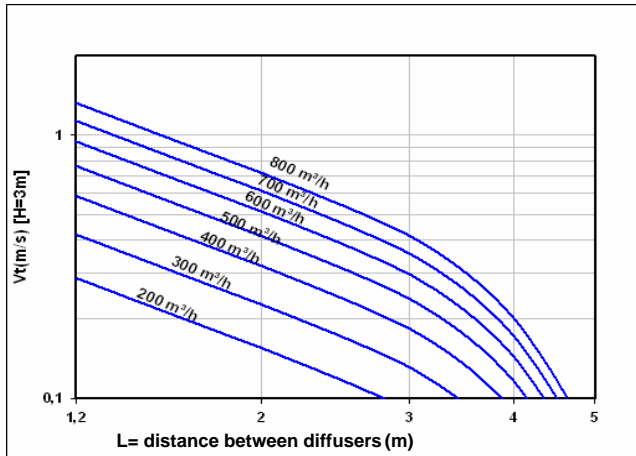

Dps = Static pressure loss (Pa)
measure with steel sheet plenum,

$Lw(A)$ = Acoustic power level
pondered in 'A' dB(A)

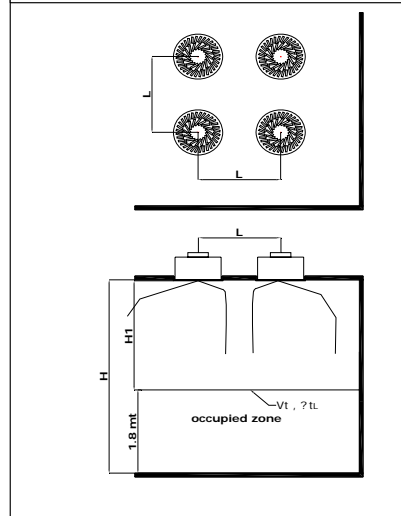

Legend:

H height of installation

1,8m height of occupied zone

Values are expressed in isothermic conditions $\Delta T=0$ K

ΔT =Temperature difference between injected air and room temperature.

Conversion table for different installation heights.

H(m)	K
2,70	1,33
3,00	1,00
3,40	0,75
3,80	0,60

example:

$H=3,4$ m

$V_t(H=3,4)=V_t(H=3) \times K=V_t(H=3) \times 0,75$

For installation in a open space $V_t=V_t \times 0,7$



HIGH INDUCTION DIFFUSERS WITH VARIABLE GEOMETRY

Ak in m²

VALUES FOR THE EFFECTIVE AIR PASSAGE SURFACE Ak FOR THE VARIOUS MODELS AVAILABLE FOR KW SERIES DIFFUSERS, MEASURES IN m²

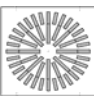
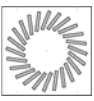
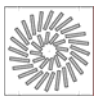
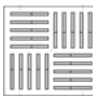
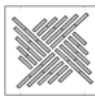
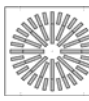

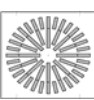
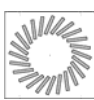
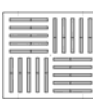
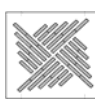
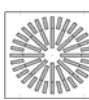
NOMINAL DIMENSIONS							
DIMENSIONS	n° deflectors	KQ 1	KQ 2	KQ 3	KQ 5	KQ 6	KQ 8
200 x 200	4	0,0026					
300 x 300	8	0,0071				0,0104	
300 x 300	11		0,0103				
400 x 400	16	0,0189	0,0195				0,0189
400 x 400	24					0,0265	
400 x 400	32				0,0365		
500 x 500	16		0,0243				
500 x 500	24						0,0253
500 x 500	28					0,0365	
500 x 500	32	0,0337					
500 x 500	40	0,0495			0,0526		
600 x 600	24		0,0361				
600 x 600	36			0,0465			
600 x 600	40				0,0671	0,0539	
600 x 600	48	0,0595		0,0499			0,0595
625 x 625	24		0,0361				
625 x 625	36			0,0465			
625 x 625	40				0,0671	0,0539	
625 x 625	48	0,0595		0,0499			0,0595
800 x 800	72	0,1053					
800 x 800	88			0,0913			
825 x 825	72	0,1053			0,0890	0,1002	
825 x 825	88			0,0913			





NOMINAL DIMENSIONS							
DIMENSIONS	n° deflectors	KQ 1 T	KQ 2 T		KQ 5 T	KQ 6 T	KQ 8 T
200	4	0,0026					
300	8	0,0071				0,0104	
300	11		0,0103				
400	16	0,0189	0,0195				0,0189
400	24					0,0265	
400	32				0,0365		
500	16		0,0243				
500	32	0,0337			0,0526		
500	40	0,0495				0,0364	0,0495



HIGH INDUCTION DIFFUSERS WITH VARIABLE GEOMETRY

Ak in m²

NOMINAL DIMENSIONS				
DIMENSIONS	n° deflectors	KQ 1 R	KQ 2 R	KQ 3 R
300	8	0,0071		
300	11		0,0103	
400	16	0,0189	0,0195	
500	16		0,0243	
500	32	0,0337		
500	40	0,0495		
600	24		0,0361	
600	36			0,0465
600	48	0,0595		0,0499
625	24		0,0361	
625	36			0,0465
625	48	0,0595		0,0499
800	72	0,1053		
800	88			0,0913
825	72	0,1053		
825	88			0,0913

NOMINAL DIMENSIONS						
DIMENSIONS	n° nozzles	KQ 40	KQ 40 T	KQ 40 R	KQ 42	KQ 42 T
400 x 400	22	0,0057	0,0057	0,0057		
400 x 400	24				0,0062	0,0062
500 x 500	44	0,0114	0,0114	0,0114		
500 x 500	48				0,0124	0,0124
600 x 600	74	0,0191		0,0191		
600 x 600	80				0,0206	
625 x 625	74	0,0191		0,0191		
625 x 625	80				0,0206	

CODES

KQ circular motion diffuser
 1 / 2 / 3 / 5 / 6 / 7 / 8 with variable geometry with combined throws
 40 / 42 with directional nozzles
 R circular
 T on 595x595 panel

Example : KQ1 T 400 - Diffuser with variable geometry with a 400 mm diameter on 595x595 panel.

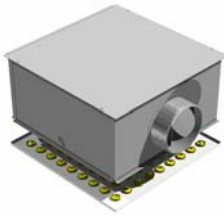

HIGH INDUCTION DIFFUSERS WITH VARIABLE GEOMETRY

INSTALLATION EXAMPLE

KQ
SERIES

INSTALLATION INSTRUCTIONS:

The diffuser is installed directly on the plenum, as illustrated below.

The diffuser is secured directly onto the plenum bridge with a M5 screw through the centre, or directly onto the plenum itself with screws at the sides. The 595x595 integrated panel is installed just as a standard false ceiling panel would be.

Figure no. 7

Fastening to plenum (diffuser with 595x595 panel)

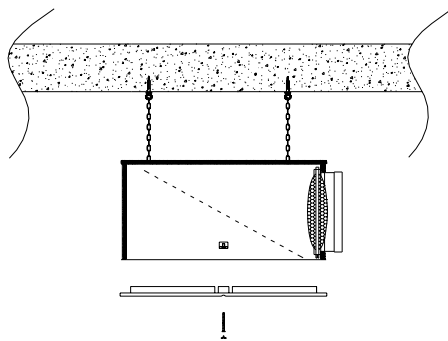

Figure no. 8

Fastening to plenum (300x300 400x400 500x500 625x625 mm diffusers)

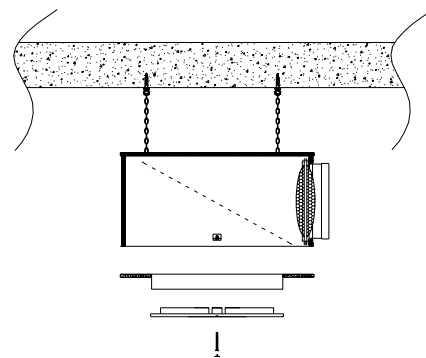

Figure no. 9

Fastening to plenum with diffuser and plenum mounted on false ceiling

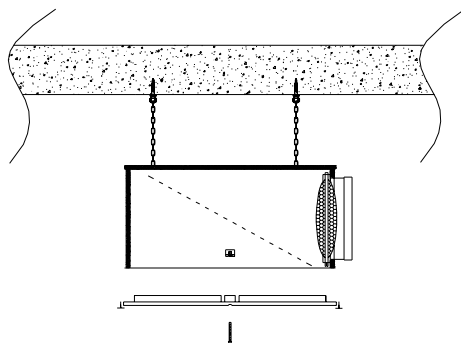

Figure no. 10

Diffuser without plenum mounted on false ceiling



PLENUM :

The diffuser can be supplied with a plenum as for your requirements.

Construction :

Constructions can also come with a side or a top coupling in the diameters shown. They can also be supplied with a regulation damper and external heat insulation in accordance with the purchaser's specifications. The control damper must be enabled from inside and can be easily reached by removing the false ceiling panel.



PLENUM FOR HIGH INDUCTION DIFFUSERS KQ SERIES

PP 80
SERIES

TECHNICAL CHARACTERISTICS

PP80 ESIP KQ Plenum + equalizer + damper + insulation + assembly bar	PP80 EIP KQ Plenum + insulation + damper + assembly bar
--	---

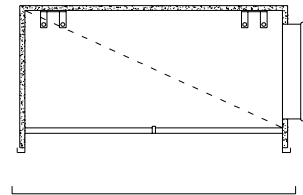
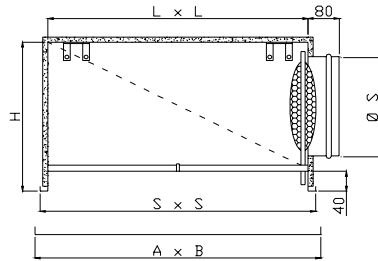

PP80 ESP KQ Plenum + equalizer + damper + assembly bar	PP80 EP KQ Plenum + equalizer + assembly bar
--	--

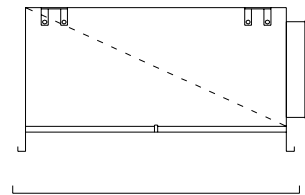
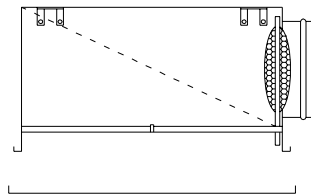

TECHNICAL DATA : PP 80 series plenum box can be supplied with lateral coupling.

MATERIALS : The plenum is manufactured from galvanized sheet steel, equalizer with perforated sheet, damper with perforated sheet, external insulation has fire reaction class I.

ADJUSTMENT : The calibration damper is regulated by a control inside the plenum, taking off the diffuser unscrewing the central bolt.

MOUNTING : The plenums are fixed and adjusted to the ceiling by threaded bars, putted into suitable supports.

Diffuser nominal sizes A x B	Real panel sizes	L x L	S x S	H	No. Couplings	S
200 x 200	196	160	190	200	1	96
300 x 300	296	260	290	200	1	123
400 x 400	396	360	390	300	1	199
500 x 500	496	460	490	300	1	199
600 x 600	596	560	590	350	1	250
625 x 625	621	585	615	350	1	250
800 x 800	796	760	790	400	1	301
825 x 825	821	785	815	400	1	301



**PLENUM FOR HIGH INDUCTION DIFFUSERS
KQ SERIES**

PP 81
SERIES

TECHNICAL CHARACTERISTICS

PP81 ESIP KQ Plenum + equalizer + damper + insulation + assembly bar	PP81 EIP KQ Plenum + equalizer + insulation + assembly bar
--	--

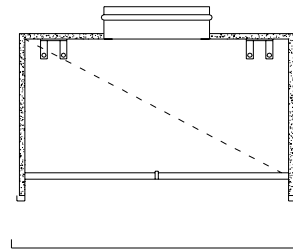
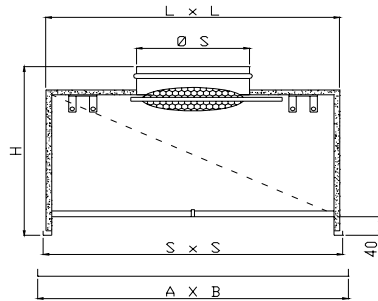

PP81 ESP KQ Plenum + equalizer + damper + assembly bar	PP81 EP KQ Plenum + equalizer + assembly bar
--	--

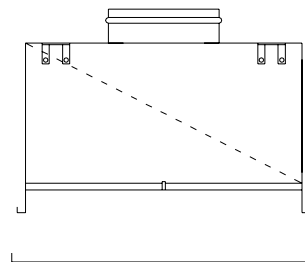
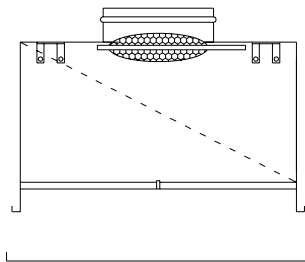

TECHNICAL DATA: PP 81 series plenum box can be supplied with upper coupling.

MATERIALS: The plenum is manufactured from galvanized sheet steel, equalizer with perforated sheet, damper with perforated sheet, external insulation has fire reaction class I.

ADJUSTMENT: The calibration damper is regulated by a control inside the plenum, taking off the diffuser unscrewing the central bolt.









MOUNTING: The plenums are fixed and adjusted to the ceiling by threaded bars, putted into suitable supports.

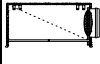

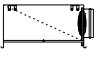





Diffuser nominal sizes A x B	Real panel sizes	L x L	S x S	H	No. Couplings	S
200 x 200	196	160	190	200	1	96
300 x 300	296	260	290	240	1	123
400 x 400	396	360	390	290	1	199
500 x 500	496	460	490	290	1	199
600 x 600	596	560	590	290	1	250
625 x 625	621	585	615	290	1	250
800 x 900	796	760	790	400	1	301
825 x 825	821	785	815	340	1	301

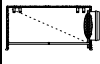

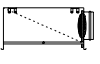
PLENUM FOR HIGH INDUCTION DIFFUSERS KQ SERIES

CODES

Nominal sizes								
	Plenum for square diffuser + equalizer + damper + insulation + assembly bar	Plenum for square diffuser + equalizer + insulation + assembly bar	Plenum for square diffuser + equalizer + damper + assembly bar	Plenum for square diffuser + damper + assembly bar	Plenum for square diffuser + equalizer + assembly bar	Plenum for square diffuser + damper + assembly bar	Plenum for square diffuser + insulation + assembly bar	Plenum for square diffuser + assembly bar
DIMENSIONS	PP80ESIP KQ	PP 80 EIP KQ	PP 80 ESP KQ	PP80SIP KQ	PP 80 EP KQ	PP 80 SP KQ	PP 80 IP KQ	PP 80 P KQ
	PP81ESIP KQ	PP 81 EIP KQ	PP 81 ESP KQ	PP81SIP KQ	PP 81 EP KQ	PP 81 SP KQ	PP 81 IP KQ	PP 81 P KQ
200 x 200	X	X	X	X	X	X	X	X
300 x 300	X	X	X	X	X	X	X	X
400 x 400	X	X	X	X	X	X	X	X
500 x 500	X	X	X	X	X	X	X	X
600 x 600	X	X	X	X	X	X	X	X
625 x 625	X	X	X	X	X	X	X	X
800 x 800	X	X	X	X	X	X	X	X
825 x 825	X	X	X	X	X	X	X	X

Nominal sizes								
	Plenum for circular diffuser + equalizer + damper + insulation + assembly bar	Plenum for circular diffuser + equalizer + insulation + assembly bar	Plenum for circular diffuser + equalizer + damper + assembly bar	Plenum for circular diffuser + equalizer + assembly bar	Plenum for circular diffuser + damper + insulation + assembly bar	Plenum for circular diffuser + damper + assembly bar	Plenum for circular diffuser + insulation + assembly bar	Plenum for circular diffuser + assembly bar
DIAMETER	PP80ESIP KQR	PP 80 EIP KQR	PP 80 ESP KQR	PP80SIP KQR	PP 80 EP KQR	PP 80 SP KQR	PP 80 IP KQR	PP 80P KQR
	300	X	X	X	X	X	X	X
400	X	X	X	X	X	X	X	X
500	X	X	X	X	X	X	X	X
600	X	X	X	X	X	X	X	X
625	X	X	X	X	X	X	X	X
800	X	X	X	X	X	X	X	X
825	X	X	X	X	X	X	X	X

PP Plenum
 80 Side coupling
 81 Upper coupling
 E Equalizer
 S Calibration damper
 I Insulation

P Assembly bar
 V Central bolt with cap

Example : PP 80 I 600x600 - Plenum with lateral coupling and insulation, dimensions 600x600



PS PLENUM

PPS SERIES

OVERVIEW

OVERVIEW :

The PPS series of polystyrene assemblable plenum boxes have a density of 45 kg/m³, with a Fire class 1 quality, eternally crystallised.

The transformation process and the special properties of the material, make the PPS a very compact and lightweight plenum.

These special features combined to the trapezoidal shape that distinguish it, allows the fixing of the unit in completed countersealing structure. This facilitates both the realisation and maintenance of the system. Given the light weight, the plenum is positioned on the structure of the counter ceiling, eliminating therefore the necessity of using hanging clips for fixing to the ceiling.

This has the advantage of reducing considerably the fitting time and a saving of the space used of over 50%, compared to a traditional plenum box.

The PPS has an excellent thermal acoustic insulation characteristic. It does not therefore require additional insulating material.

The PPS plenums can be supplied already assembled with a square 600x60mm diffuser panel, model KQ1, complete with regulation damper in ABS and equalizer, ready for installation.

As an alternative, there is also a version assembled but without the diffuser fitted.

Lastly a kit is also available, comprising the plenum, the connection 'C', bar 'A' and assembly diagram.

Installation: once the diffuser has been fitted to the plenum using the screw 'V' (PPS-V680T) to bar 'A', the plenum is positioned on the counter ceiling structure.

TECHNICAL CHARACTERISTICS:

fire reaction:
Class 1 - Test report CSI DC01/378F05.
Euroclass E - Test report CSI DC01/656F07

Mechanic resistance:
10% deformation with 226kPa pressure - Test report CSI 0936/FPM/MATs/07.

Water absorption:
Increase average volume 3,26% in full immersion, tested according to UNI EN 12087 method 2A - Test report CSI 0936/FPM/MATs/07_2.

Thermal conductivity:
 Δ (average) 0,0320 W/mK - Test report CSI 0037/DC/TTS/07.

Thermal resistance:
R (average) 0.637 m²K/W - Test report CSI 0037/DC/TTS/07.

Test certificate type:
Certificate CSI DE/1831/07 issued in conformity to directive 89/106/CEE on the basis of UNI EN 13163/2003 and UNI EN 13172/2003.

The documentation indicated above can viewed in electronic form in Italian with prior agreement from the Technical Department.

ASSEMBLED PPS

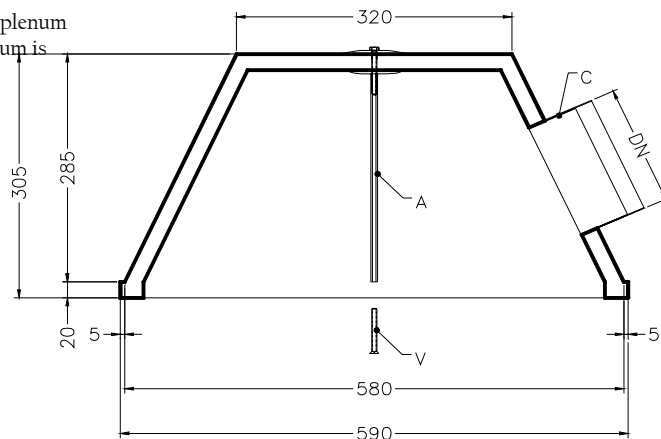





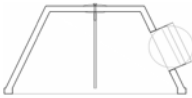

PS PLENUM

CODES

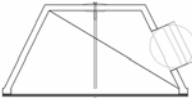
PPS
SERIES

Image	Description	Connector diameter	Code
	Plenum in PS already assembled with connector in ABS with damper and without equalizer.	160	PPS-PS160
		200	PPS-PS200
		250	PPS-PS250
	Plenum in PS already assembled, complete with connector in ABS with damper and equalizer.	160	PPS-PES160
		200	PPS-PES200
		250	PPS-PES250
	Plenum in PS already assembled, complete with connector in ABS with damper, equalizer and diffuser KQ1 600.	160	PPS-KQIPES160
		200	PPS-KQIPES200
		250	PPS-KQIPES250

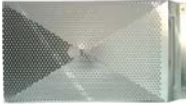
ACCESSORIES

	Only PS bell shape body with fixing bar (withour connector)		PPS-KIT
	Equalizer for plenum		PPS-E
	Fixing screw for fixing diffuser to plenum.		PPS-V680T
	Connector in ABS	160	RR10-160
		200	RR10-200
		250	RR10-250
	Damper for connectors in ABS	160	RRS10-160
		200	RRS10-200
		250	RRS10-250