



## CIRCULAR DIFFUSERS WITH INDIVIDUALLY ADJUSTABLE CONES

GENERALITA'

KU 5  
KU 6  
KU 8  
SERIES

**TECHNICAL DATA :** KU diffusers are constituted by the external frame and the central part: The central part is removable and all cones can be adjusted with high accuracy, independent from each other.

The different positioning of circular elements permit to change the air direction, in order to obtain mixed or singular air flows, in both, vertical and horizontal, directions.

Consequently the possibility of regulation, this air terminal device is suitable for all applications that require cooling and heating. Of course, this item can be also used for intake air applications.

Air terminal devices KU are used for installation height between min.2,6 and max. 6 meters.

**MATERIALS :** External frame and removable central part are made of aluminium sheet. They are painted white RAL 9010. The model KU6, KUT6, KU8 e KUT8 have regulation in polymeric material (ABS).

**MOUNTING :** The diffuser is fixed with screws at the sides, directly to the channel or the plenum.

**DIFFUSER REGULATION :** It can be manual without control, with singular registration of each cone position ( models KU5 and KUT5 ).

**BUTTERFLY GATE REGULATION :** Manual, by screwdriver on diffuser's front side.

NOMINAL DIAMETER in mm.	N° PCS. FOR PALLET - WEIGHT KG. FOR PALLET - PALLET SIZES														
	KU5/6/8					KUT5/6/8					SF - SB				
	Pz.	Kg.	L	L	H	Pz.	Kg.	L	L	H	Pz.	Kg.	L	L	H
100						24	115	0,9	120	195	50	**	50	50	35
150	90	110	0,8	120	195	24	115	0,9	120	195	50	**	50	50	35
160	90	110	0,8	120	195	24	115	0,9	120	195	50	**	50	50	35
200	52	100	0,8	120	205	24	115	0,9	120	195	25	**	50	50	35
250	29	110	0,8	120	195	24	115	0,9	120	195	25	**	50	50	35
300	24	0,9	0,8	120	208	24	115	0,9	120	195					
315	24	0,85	0,8	120	208	24	115	0,9	120	195					
350	10	0,45	0,8	120	165										
355	10	0,45	0,8	120	165										
400	10	0,53	0,8	120	185										
450	10	0,56	0,8	120	205										
500	10	0,63	0,8	120	205										
630	10	0,80	0,8	120	228										



## CIRCULAR DIFFUSERS WITH INDIVIDUALLY ADJUSTABLE CONES

### TECHNICAL CHARACTERISTICS

KU 5  
KU 6  
KU 8  
SERIES

**KU5 KU6**  
Circular adjustable cones diffuser  
from Ø 100 to Ø 630 (KU6 from Ø 150 to Ø 315)

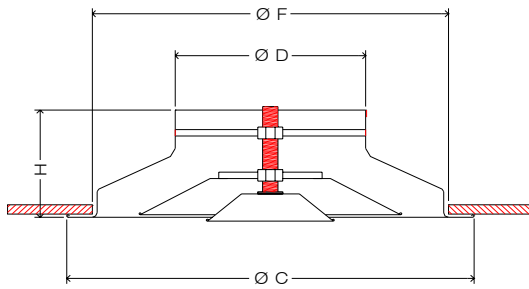

KU5 + SF with butterfly damper  
KU5 + SB with collecting gate  
KU5E with air equalizer

**KU8**  
Circular adjustable cones diffuser with butterfly gate already  
mounted from Ø 160 to Ø 315 (KU8 from Ø 160 to Ø 315)

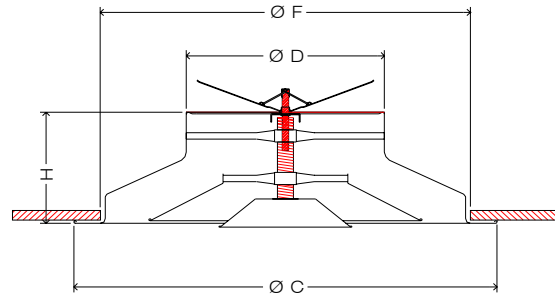

Diffusor with fix mounted butterfly gate.

**KUT5 KUT6**  
Circular adjustable cones diffuser with panel  
595 x 595 from diam. 100 to diam. 315

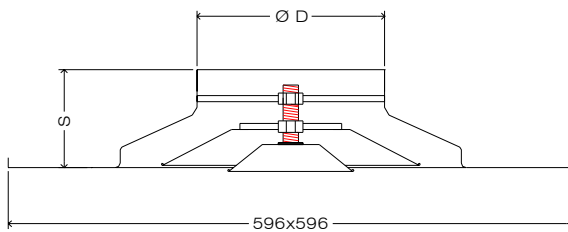

KUT5 + SF with butterfly gate.  
KUT5 + SB with collecting gate  
KUT5E with air equalizer.

**KUT8**  
Circular adjustable cones diffuser with panel 595 x 595 and  
mounted butterfly gate from diam. 160 to diam. 315

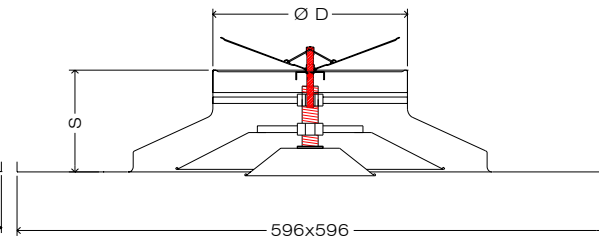

Diffusor with fix mounted butterfly gate.

MODEL	F (*)	C	D	H	S	N° cones
100	198	230	98	75	70	1
150	288	335	148	105	100	2
160	288	335	158	105	100	2
200	370	423	198	118	110	2
250	461	517	248	130	120	2
300	576	640	298	146	126	2
315	576	640	313	146	126	2
350	656	730	348	185	--	2
355	656	730	353	185	--	2
400	700	776	398	185	--	3
450	755	825	448	185	--	3
500	825	917	498	185	--	3
630	963	1045	628	185	--	4

(\*) F = counter ceiling opening size already increased as necessary.

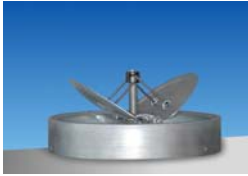

**CIRCULAR DIFFUSERS WITH  
INDIVIDUALLY ADJUSTABLE CONES**

ACCESSORIES AND MOUNTING

KU 5  
KU 6  
KU 8  
SERIES

SF - SB

Butterfly gates and collecting gates diameter 100 to diameter 500.

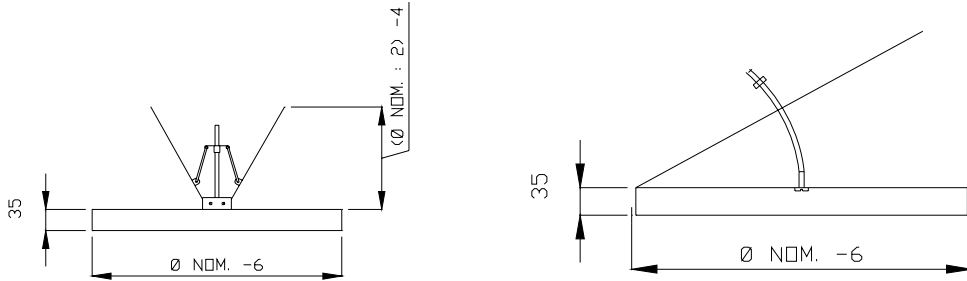

**MOUNTING EXAMPLE**

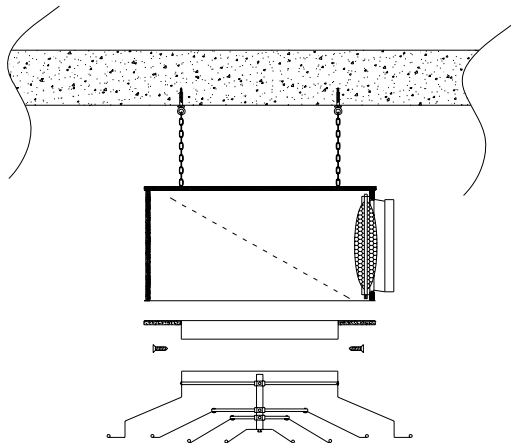
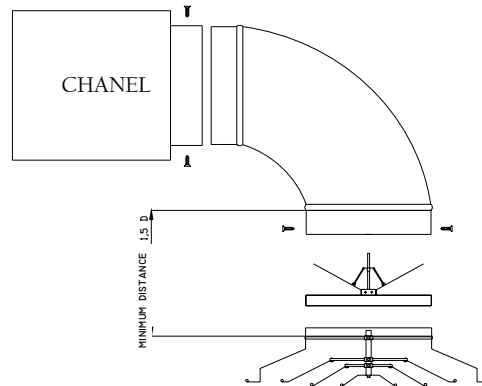
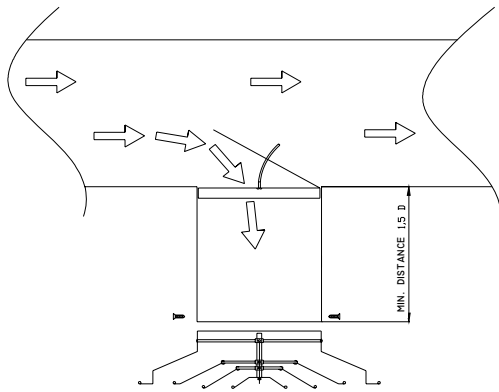

New accessory:

KU5-KD: set of 3 fixing clips and safety chain  
for plasterboard counter ceiling



## CIRCULAR DIFFUSERS WITH INDIVIDUALLY ADJUSTABLE CONES

### PERFORMANCE

KU 5  
KU 6  
KU 8  
SERIES

**KU5/6 100**

V <sub>c</sub>	2	3	4	5	6	7	8	9	10
Q	53	80	106	133	160	186	213	239	266
L <sub>x</sub>	0,5	0,7	0,9	1,2	1,4	1,6	1,9	2,1	2,3
Δp <sub>s</sub>	8	16	28	41	58	76	97	120	145
L <sub>p</sub>	--	20	28	36	42	47	52	56	60

**KU5/6/8 160**

V <sub>c</sub>	2	3	4	5	6	7	8	9	10
Q	139	209	279	348	418	488	558	627	697
L <sub>x</sub>	0,9	1,3	1,7	2,1	2,6	3,0	3,4	3,8	4,3
Δp <sub>s</sub>	8	16	26	40	55	73	93	115	139
L <sub>p</sub>	--	--	27	34	40	45	49	53	57

**KU5/6/8 200**

V <sub>c</sub>	2	3	4	5	6	7	8	9	10
Q	219	329	439	549	658	768	878	988	1097
L <sub>x</sub>	1,1	1,6	2,2	2,7	3,3	3,8	4,4	4,9	5,5
Δp <sub>s</sub>	7	15	26	38	54	71	90	112	135
L <sub>p</sub>	--	--	26	33	39	44	48	52	55

**KU5/6/8 250**

V <sub>c</sub>	2	3	4	5	6	7	8	9	10
Q	345	517	690	862	1035	1207	1380	1552	1725
L <sub>x</sub>	1,4	2,1	2,8	3,5	4,2	4,9	5,6	6,3	7,0
Δp <sub>s</sub>	7	15	25	38	53	70	89	110	133
L <sub>p</sub>	--	--	26	33	38	43	47	51	55

**KU5/6/8 315**

V <sub>c</sub>	2	3	4	5	6	7	8	9	10
Q	550	826	1101	1376	1651	1927	2202	2477	2752
L <sub>x</sub>	1,2	2,6	4,1	5,1	6,1	6,5	6,9	7,4	7,8
Δp <sub>s</sub>	7	14	24	36	50	67	85	105	127
L <sub>p</sub>	--	--	26	32	38	43	47	51	54

**KU5 355**

V <sub>c</sub>	2	3	4	5	6	7	8	9	10
Q	701	1051	1401	1752	2102	2452	2803	3153	3503
L <sub>x</sub>	2,1	3,1	4,1	5,1	6,2	6,9	7,3	7,8	8,2
Δp <sub>s</sub>	7	14	24	36	50	67	85	105	127
L <sub>p</sub>	--	--	27	34	39	44	48	52	55

**KU5 400**

V <sub>c</sub>	2	3	4	5	6	7	8	9	10
Q	891	1337	1783	2228	2674	3119	3565	4011	4456
L <sub>x</sub>	2,4	3,5	4,7	5,9	7,1	7,9	8,4	8,9	9,4
Δp <sub>s</sub>	7	14	24	36	50	66	84	104	126
L <sub>p</sub>	--	21	29	35	41	46	50	53	57

**KU5 450**

V <sub>c</sub>	2	3	4	5	6	7	8	9	10
Q	1130	1695	2260	2825	3390	3955	4520	5085	5649
L <sub>x</sub>	2,0	4,4	5,8	7,2	7,9	8,5	9,1	9,7	10,2
Δp <sub>s</sub>	7	14	24	36	50	66	84	105	127
L <sub>p</sub>	--	22	30	37	42	47	51	55	58

**KU5 500**

V <sub>c</sub>	2	3	4	5	6	7	8	9	10
Q	1397	2095	2794	3492	4190	4889	5587	6286	6984
L <sub>x</sub>	3,0	4,4	5,7	6,4	7,0	7,5	8,1	8,5	9,0
Δp <sub>s</sub>	7	14	24	36	49	65	83	103	125
L <sub>p</sub>	--	23	32	38	44	48	53	56	59

**KU5 630**

V <sub>c</sub>	2	3	4	5	6	7	8	9	10
Q	2223	3335	4446	5558	6669	7781	8892	10004	11115
L <sub>x</sub>	3,7	5,5	6,4	7,1	7,8	8,4	9,0	9,5	10,0
Δp <sub>s</sub>	6	13	22	34	47	62	78	97	118
L <sub>p</sub>	--	26	34	41	46	51	55	59	62

V<sub>c</sub> [m/s] Neck velocity  
 Q [m<sup>3</sup>/h] Air flow rate  
 L<sub>x</sub> [m] Horizontal throw  
 Δp<sub>s</sub> [Pa] Pressure drop  
 L<sub>p</sub> [dB(A)] Acoustic pressure

	150	300	350
L <sub>x</sub> [m]	x 1,10	x 1,10	x 1,00
Δp <sub>s</sub> [Pa]	x 1,39	x 1,21	x 1,00
L <sub>p</sub> [dB(A)]	+ 3	+ 2	+ 0

For the throw values of the diffusers up to model 450, we have considered an installation height of between 2.7 and 3.1 meters. For the larger models a height between 3.40 and 4.10 m was considered.

If the diffuser is mounted free in the room (without ceiling fixture), the range will decrease by approx. 40% and the cold air will exit the diffuser at an angle of approx. 20° with respect to the horizontal plane (ie. compared to an imaginary fixture).

The range values are valid for a terminal velocity of 0.25 m/s with a temperature of -11°C lower than the room temperature.

The pressure drop is valid for diffusers with or without regulation damper completely open and for horizontal range.

For the acoustic pressure levels L<sub>p</sub> an acoustic attenuation of 10 dB was taken into consideration.

Acoustic levels lower than 20 dB(A) are given by "--".

For the 150, 300 and 350 models, use values for the 160, 315 and 355 models with the required delivery and throw, pressure drop and correct noise values of the factors given in the table above.







The pressure and noise data refer to diffusers without equaliser. To obtain the data with equaliser, use a multiplying factor of 1.9 for pressure drop and add 4 dB(A) to noise.







## CIRCULAR DIFFUSERS WITH INDIVIDUALLY ADJUSTABLE CONES

CODES

KU 5  
KU 6  
KU 8  
SERIES

Image						
Codice	KU5	KU6	KU8	KUT5	KUT6	KUT8
Modello	Circular diffuser	Circular diffuser with mechanism in ABS	Circular diffuser with mounted damper and mechanism in ABS	Circular diffuser with 595 x 595 pannel	Circular diffuser with 595 x 595 pannel with mechanism in ABS	Circular diffuser with 595x595 panel mounted dmpner and mechanism in ABS
100	X	X		X	X	
150	X	X		X	X	
160	X	X	X	X	X	X
200	X	X	X	X	X	X
250	X	X	X	X	X	X
300	X	X		X	X	
315	X	X	X	X	X	X
350	X					
355	X					
400	X					
450	X					
500	X					
630	X					

### ACCESSORIES

Image				
Code	SF	SB	EK	
Model	Butterfly gate	Capturing damper	Equalizer not mounted	Equaliser mounted
100	X	X	X	X
150	X	X	X	X
160	X	X	X	X
200	X	X	X	X
250	X	X	X	X
300	X	X	X	X
315	X	X	X	X
350	X	X	X	X
355	X	X	X	X
400	X	X	X	X
450	X	X	X	X
500	X	X	X	X
630			X	X

- KU5 Circular diffuser with individually adjustable cones.
- KU6 Circular diffuser with individually adjustable cones with mechanism in ABS
- KU8 Circular diffuser with individually adjustable cones, damper and mechanism in ABS.
- T Diffuser fitted to 595x595 panel.
- EK Equaliser fitted to diffuser neck.
- SF butterfly gate
- SB Capturing damper

**Example:** KUT 5 E 200  
Circular diffuser fitted to 595x595 panel for false ceiling with equaliser, diameter 200 mm.





## PLENUM FOR CIRCULAR DIFFUSERS

PP 60  
SERIES

### MATERIALS CONSTRUCTION DIMENSIONS

#### PLENUM :

##### Construction:

The diffuser can be supplied with a plenum as for your requirements.

It can also come with a side or a top coupling in the diameters shown. The diffuser can also be supplied with a regulation gate and external heat insulation in accordance with the purchaser's specifications.

The regulation gate can be operated from outer plenum and can be easily reached by removing the false ceiling's panel.

##### MATERIALS :

Modular standard plenum (figure no. 7): galvanized sheet steel. Regulation gate: perforated sheet. Insulation: elastomer

Figura n° 7  
Plenum standard with singular inferior coupling

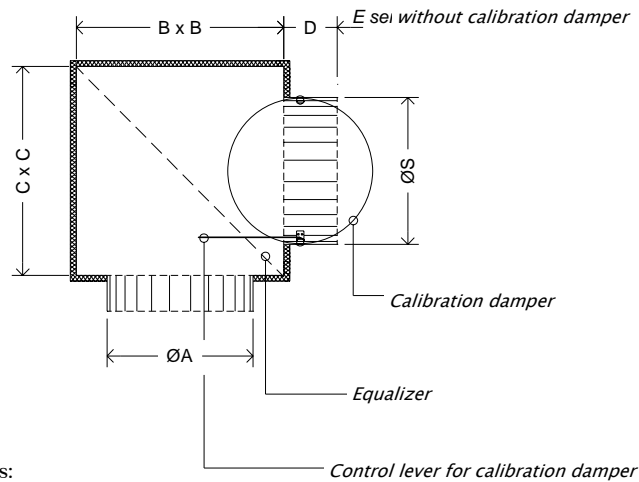

Construction dimensions:



Nominal Diameter	A [mm]	B [mm]	C [mm]	D[mm]	E[mm]	No. couplings	S [mm]
100	102	200	200	65	65	1	96
125	127	225	225	90	60	1	121
150	152	250	250	70	70	1	146
160	162	250	250	90	60	1	156
200	202	300	300	90	60	1	196
250	252	350	350	90	60	1	246
300	302	400	400	90	60	1	296
315	317	400	400	90	60	1	311
350	352	450	450	90	90	1	346
355	357	450	450	90	90	1	346
400	402	500	500	90	90	1	396
450	453	550	550	100	100	1	446
500	503	600	600	100	100	1	496
630	633	730	730	100	100	1	600
800	803	900	900	90	90	2	396x2



## PLENUM FOR CIRCULAR DIFFUSERS

PP 60  
SERIES

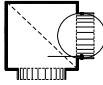
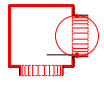
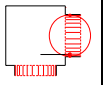
AVAILABLE SIZES

Nominal Measures				
Diameter	PP 60 ESI	PP 60 SI	PP 60 S	PP 60
100	X	X	X	X
125	X	X	X	X
150	X	X	X	X
160	X	X	X	X
200	X	X	X	X
250	X	X	X	X
300	X	X	X	X
315	X	X	X	X
350	X	X	X	X
355	X	X	X	X
400	X	X	X	X
450	X	X	X	X
500	X	X	X	X
630	X	X	X	X
800	X	X	X	X

PP Plenum  
60 for circular diffuser  
E Equalizer  
S Damper  
I Insulation

Example: PP 60 ESI 200  
Plenum for circular diffuser with equalizer, damper and insulation for circular diffuser Ø 200 mm.